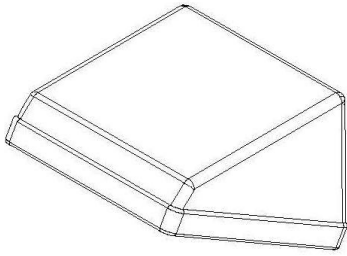
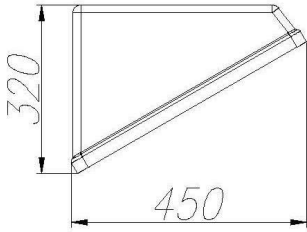

PRODUCT OVERVIEW SUNSHADES SPS-150

PRODUCT	DESCRIPTION
SUNSHADES SPS-150 - DIMENSION 412 mm (W) x 320 mm (H) x 450 mm (D)	
<p>SPS-150</p> 	<p>SUNSHADE TYPE SPS-150</p> <p>This type of sunshades are made with half of instrument protection box, this sunshade is extracted from CPS-150 instrument protection box.</p> <p>The enclosure are made in fiber glass reinforced polyester thickness to 3 mm in standard colour light grey RAL 7035.</p> <p>A small canopy with a bracket that allows it to attach directly onto the body of a transmitter or mounting to the pipe stand or steel construction.</p>
	<p>Sunshield or commonly called sunshades are different type of instrument protection against:</p> <ul style="list-style-type: none"> • Sun light (overheating) • Dirt accumulation • Exposure to atmospheric conditions • Mechanical damage
SUNSHADES SPS-150	
SPS-150-0	Plate with 2" U-bolts
SPS-150-1	Wall Mounting Brackets